

GSM/SMS Alarm System

User Manual

Foreword

Dear Customers,

Thank you for choosing our product. This product is a totally D.I.Y. wireless home security solution. It features automatic connection to various accessories, putting your home under all-round protection. To experience this wonderful product, please follow the instructions in the user manual.

Contents

In the Box	1~2
Included Accessories	2
How It Works	3
Accessories	4~9
Remote Control	4
Door/Window Contact	5
PIR Motion Detector	6
Zone Mode of Sensor	8
Getting Started	9~12
Step 1. Insert SIM Card	9
Step 2. Download the App	9
Step 3. Add an Account	10
Step 4. Be Familiar with the Alarm System	10
Step 5. System Settings	11
Setting through SMS	13~14
Other SMS Notifications	14
Installation	15~18
Sensor Placement	15
Installation Mode	16
Placing the Control Panel	17
Mounting the Door/Window Contact	17
Mounting the PIR Motion Detector	18
Pairing/Deleting Accessory	19~20
Pairing New Remote Control and Sensor	19
Pairing New Wireless Siren	20
Deleting Sensors	20
Deleting Wireless Siren	20
Reload the Batteries of Accesories	21
Arm & Disarm by Free Phone Call	22
Restore to Factory Settings	22
Specifications	23~24
Control Panel	23
Remote Control	23
Door/Window Contact	24
PIR Motion Detector	24
Disclaimer	25

In the Box

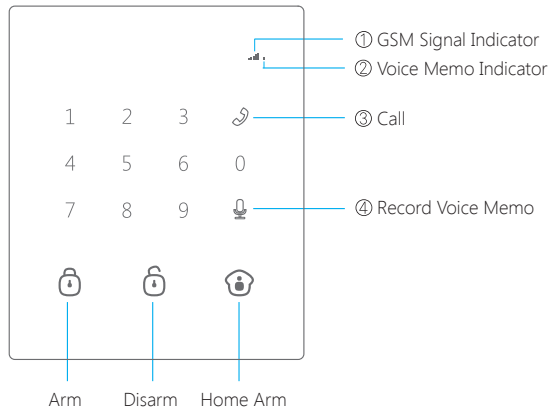

- ① Flashes once per second: Searching network.
 Flashes once per 3 seconds: Connected with network.
- ② Blinking: There is a new voice memo.
- ③ Enter a phone number and press this call button to make a call.
- ④ Press and hold it for 3 seconds to leave a 10-second voice memo.
 Press once to listen to a new voice memo or replay.

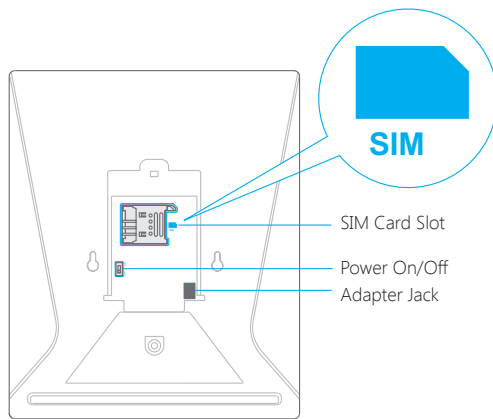

System Status

Arm: Press [] to arm your system. Now all the sensors are on guarding.

Disarm: Enter the password (default setting: 1234) and press [] to disarm your system. Now your system stops handling alarm signal from sensors (except these sensors in 24-H zone).

Home Arm: Press [] to part arm your system. Now your system only stops handling alarm signal from home mode zone sensors, which enables users to move freely at home.

Included Accessories

This alarm system has the following accessories included in the box.

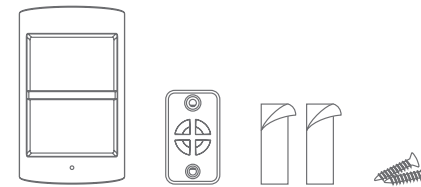

PIR Motion Detector x 1

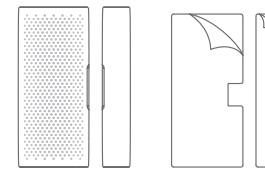

Door/Window Contact x 1



Remote Control x 2



AC Adapter x 1



User Manual x 1

How It Works

The control panel will receive an alarm signal when a sensor is triggered, it will hoot and inform users by sending SMS and making calls.

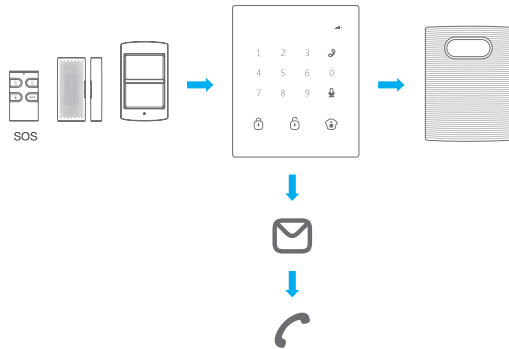

When you receive a phone call from the control panel, you will hear your pre-recorded alarm voice message first, and then you can remotely control the system by pressing the numbers on your phone keyboard.

Operation	Function
0	Disarm
1	Arm
6	Turn off siren
9	Turn on siren
*	Two-way talk
#	Hang up

You can record an alarm voice message by the following steps:
Enter disarm password (default setting: 1234), and then press [🏠] and [📞] button to leave a 10-second alarm message.

Distinction

Voice memo: Message is recorded to your family members.

Alarm voice message: Message is played when you pick up an emergency call.

Accessories

Remote Control

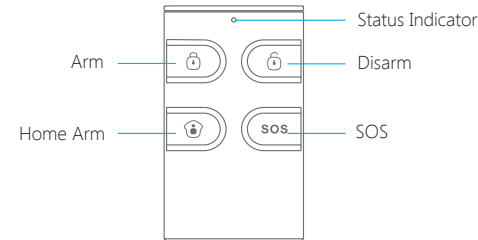

Button	System Status
🔒	Press once to arm. The siren beeps once to confirm the system is armed.
🔒	Press once to disarm. The siren beeps twice confirm the system is disarmed.
🏠	Press once to home arm. After 3 seconds, the siren beeps once to confirm the system is in home mode. <i>Note:</i> The control panel only stops handling alarm signal from the home mode zone sensor, which enables users to move freely at home.
SOS	The control panel will hoot on-site with indicator flashing, and users will receive SMS and calls.
🏠 + 🔒	Press the [🏠] button. After the indicator on the remote control blinks once, press [🔒] button within 3 seconds to mutely arm the system.
🏠 + 🔒	Press the [🏠] button. After the indicator on the remote control blinks once, press [🔒] button within 3 seconds to mutely disarm the system.

Door/Window Contact

The contact contains a transmitter and a magnet. It can be mounted on doors, windows and any other objects that can be opened or closed. When the transmitter and magnet are separated over 2 cm, the contact will send a signal to the control panel to trigger an alarm.

Overview

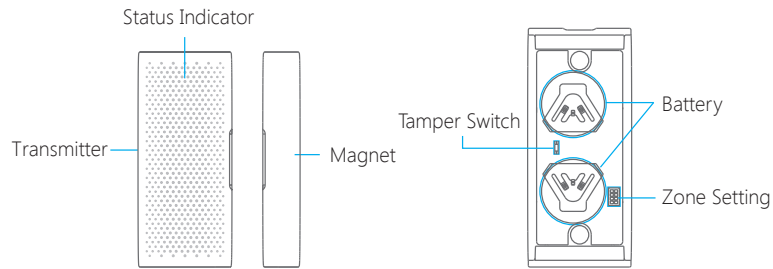

Status Indicator

Blinks once: Door/window is opened.

Blinks once per 3 seconds: Low battery, please replace battery.

Note: When tamper switch is pressed, the system will alarm immediately.

PIR Motion Detector

The detector adopts digital dual-core fuzzy logic control processing technology and intelligent analyze algorithm. When human body's infrared spectrum is detected, it will send alarm signal to the control panel.

The detector features pet immunity for animals up to 25kgs.

Overview

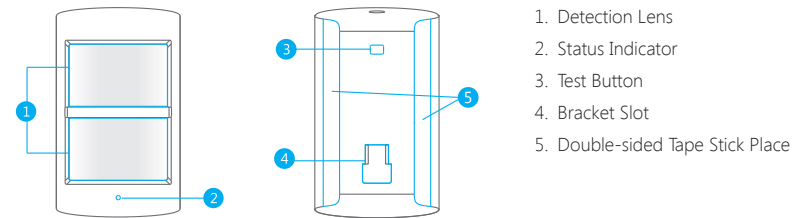

Status Indication

Blinks continuously: Motion detector performs a self-test.

Blinks once: Motion is detected.

Blinks twice: Motion detector has exited testing mode, and goes to power saving mode.

Blinks once per 3 seconds: Low battery, please replace battery.

PCB Layout

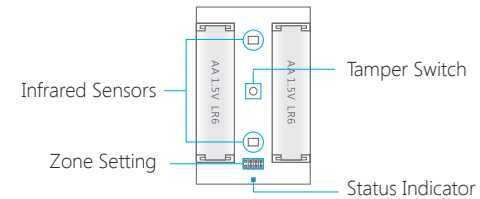

Tamper Switch: When the tamper switch is pressed, system will alarm immediately.

Infrared Sensors: The infrared sensors detect movement, and please make sure they are always clean.

Working Mode

Testing Mode

After a 1 minute self-test, the detector enters a testing mode. It detects once in every 10 seconds and emits alarm signal when motion is detected. This will last for 3 minutes and then switches into power saving mode.

Note: You can press the test button to enter testing mode too.

Power Saving Mode

If the PIR motion detector detects movements twice in 3 minutes, it automatically goes into asleep state. If there is no movement detected in next 3 minutes, it will switch from asleep state to arm. During the 3 minutes, the detector won't be active and send any signals to the control panel. As long as there is a movement detected within 3 minutes, the duration of power saving mode will be extended.

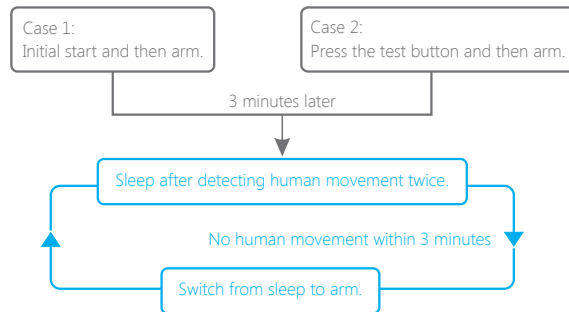

Detection Range

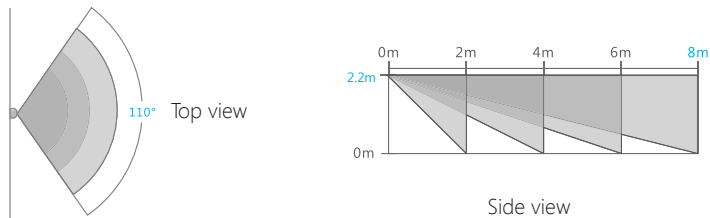

Pet-Immune Function

This sensor adopts a special design to improve detection accuracy. Pets less than 25kgs will not trigger the alarm.

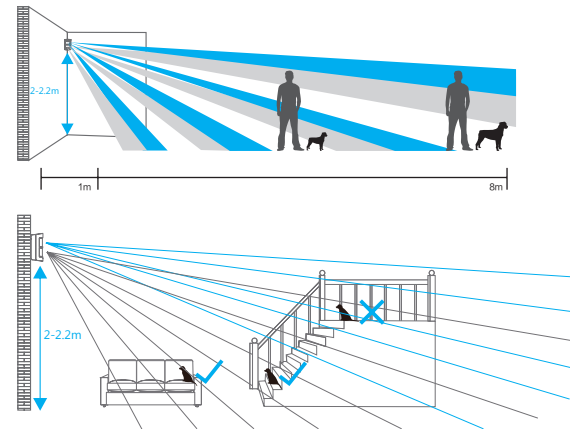

Zone Mode of Sensor

Sensors can be placed in different zones for different requirements. Four different zones can be selected:

Normal zone: In arm or home arm state, the detectors set to normal zone work normally. Once intrusion is detected, the detectors trigger an alarm.

Home zone: When system is in home arm state, the detectors set to home zone are disarmed. The detectors set to other zones are armed. That is, partial arm.

Single delay zone: Sensors set to this zone will alarm at the specified time (which can set by yourself) after being triggered.

24-H zone: The detector set to 24-H zone trigger an alarm immediately when detecting intrusion, no matter the system is armed or disarmed.

Sensors in This Kit	Zone Mode (Default Setting)
Door/Window Contact	Normal Zone
PIR Motion Detector	Home Mode Zone

You can set zone by changing the jumpers in detector. After the setting, detector can work in corresponding mode. It must be paired to the control panel again.

How to set:

Open the rear cover of the detector; change the array of jumpers on the zone setting to the corresponding position as below (Mind the direction of D0-D3):

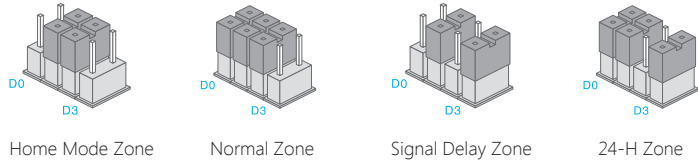

Getting Started

Step 1. Insert SIM Card

Before inserting the SIM card, please perform the following steps:

1. Make sure the alarm system is powered off.
2. IMPORTANT: Remove the (default) code permanently from the SIM card.
3. Turn off the voice mail function if it is enabled.
4. Insert the SIM card into the SIM card slot; wait until the GSM indicator starts blinking once every 3 seconds; it means the network is connected.

SIM card requirement: 2G GSM SIM card with calling, SMS and caller display functions.

Step 2. Download the App

Download the App by searching keywords "O2 Alarm" in the App Store or Google Play, and then create your own account.



Step 3. Add an Account

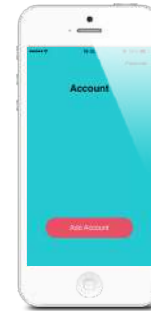

Step 4. Be Familiar with the Alarm System

Now you can tap [🔒], [🔓], [🏠] to arm/disarm/home arm your system remotely. Tap [📧] and app will skip to messages interface automatically. After sending the SMS, you will receive a phone call from the control panel to leave a 10-second voice memo. Tap [🗨️] and app will skip to messages interface automatically. After sending the SMS, you will receive a phone call from the control panel to start a two-way talk.



Step 5. System Settings



Store Emergency Numbers & SMS Numbers

Emergency numbers are the phone numbers that will receive calls from the control panel when the alarm goes off.
SMS numbers are the phone numbers that will receive alarm SMS from the control panel when the alarm goes off.

IMPORTANT: After phone numbers are stored, only those numbers can modify the system settings. Commands from unauthorized phone numbers will be rejected.
Once an alarm is triggered, the control panel will dial the emergency numbers 3 rounds at most, if a phone is picked up with operation on phone button, the system will stop dialing.

Store Speed Dial Number

After the number is stored, you can dial this number immediately by pressing [📞] button once on the control panel.

Change Zone Name

10 remote controls and 50 sensors could be extended and the names of sensors are able to be edited.
This function aims at guiding users to identify the invasion location quickly by changing the sensor name. Their sequence in naming follows pairing order. For example, the first paired sensor is by default set to zone 1; the second paired sensor is by default assigned to zone 2, etc. In case of emergency, if you did not change the sensor name, this control panel will send SMS with zone number to user (e.g. Zone 1 Alarm).

Exit & Entry Delay Time

If you don't want to carry remote controls, you can set the exit or entry delay. Suppose entry delay was set at 30 seconds, the system will allow you 30 seconds to disarm the system before alarming. Suppose exit delay was set at 35 seconds, the system will allow you 35 seconds to leave before the system is armed. The "beep" is heard in every second to remind you to leave. The pace of reminding sound will speed up in last 15 seconds. Thus leaves you enough time to leave home without triggering the system.

Single Zone Delay Time

(To apply this function, you should change the zone mode of the sensor to single delay zone first. Please refer to "Zone Mode of Sensor" on page 9).
After the time setup, the single delay zone sensor will delay to alarm when it is triggered.

Comparison

For example: The exit & delay time is set at 30 seconds; single zone delay time is set at 40 seconds.

Sensor	Arm	Alarm
Normal and home mode zone	Delay 30s to arm	Delay 30s to alarm
Single delay zone	Delay 30s to arm	Delay 40s to alarm
24-H zone	Always in arm state	Alarm immediately

Disarm Password

The default disarm password is 1234. It is suggested to change the passcode for safety.

Setting through SMS

If you use a non-smart phone, you can set your system by sending the related SMS command codes to the SIM card in the control panel.

Item	SMS Command Code
SMS menu	?, ??, ???
System setting inquiry	00
Disarm	0
Arm	1
Home arm	2
Two-way talk	3
Call back to leave a 10-second voice memo	4
Store emergency telephone numbers	5
Store emergency SMS numbers	6
Store speed dial numbers	8
Change zone name	901~950
Set exit & entry delay time	11
Set alarm volume and ringing time	12
Change disarm passcode	13
Set single zone delay time	14

For example:

1. Send "5" to the SIM card number of the control panel.



2. You will receive a menu SMS from the control panel.

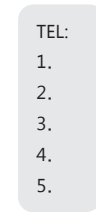

3. Copy and edit the menu message, and then send it back.

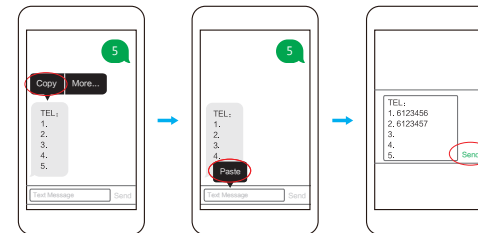

4. You will receive a SMS for confirmation from the control panel.

Other SMS Notifications

You will receive SMS for reminding you:

1. When the control panel and sensors are in low battery, the 1st stored phone number will receive a SMS.
2. When the AC power of control panel fails or restores, the 1st stored phone number will receive a SMS.
3. When the tamper switch of sensors trigger an alarm, all the stored phone numbers will receive a SMS.

Installation

Sensor Placement

The alarm system is most effective with well-placed sensors. Determine which area you want to guard and what kind of detectors should be used. The following picture is the potential places shown for different types of detectors. You can refer it to choose an ideal place.

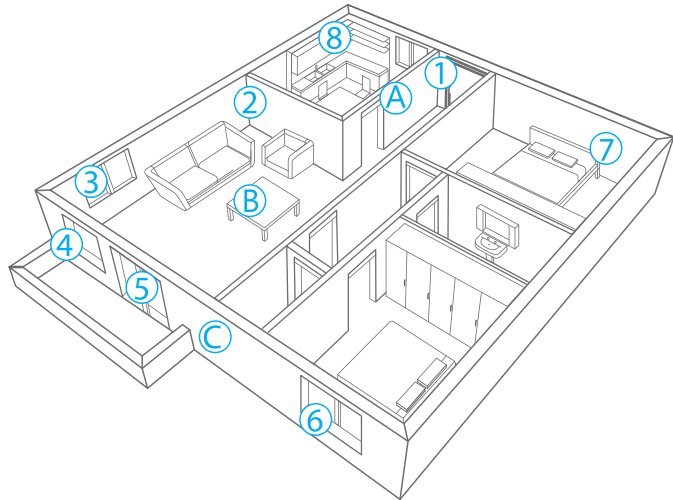

A. Alarm panel B. Remote control C. Wireless Siren

- | | |
|------------------------|---------------------|
| 1. Front door | Magnet contact |
| 2. Living area | PIR motion detector |
| 3. Window: living area | Magnet contact |
| 4. Window: living area | Magnet contact |
| 5. Terrace door | Magnet contact |
| 6. Window | Magnet contact |
| 7. Bedroom | PIR motion detector |
| 8. Kitchen | Gas detector |

Installation Mode

There are possibilities to trigger an alarm when mounting the sensors. You can press the [🔒] button for 3 times on the control panel to enter the 10-minute installation mode. During this period, system only beeps 3 times when the sensor is triggered. You can also press [🔒] button on the control panel to exit this mode.

Placing the control panel

There are two installation methods for users. The one is placing the control panel on the desk; the other one is mounting it on wall by using the supplied screw kit. Please choose an ideal place and suitable method to mount your control panel.

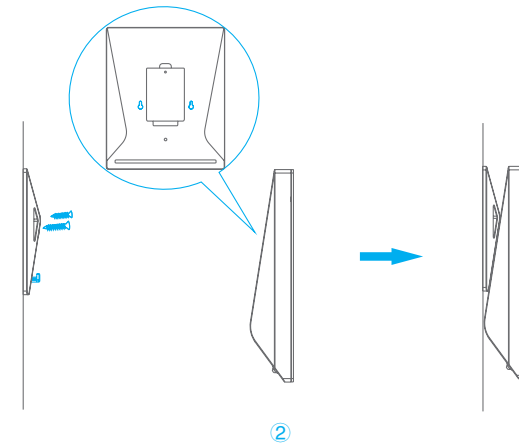
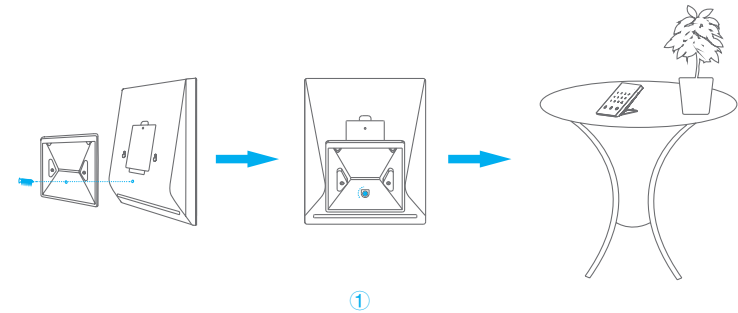

Mounting the Door/Window Contact

Make sure the contact works properly before installation.

Step 1: Choose a suitable installation location

It can be installed on doors, windows or any other objects that can be opened or closed. If it is applied to metal doors, please place a spacer under the transmitter and magnet.

Step 2: Secure the contact with the supplied sticker

Make sure the gap marks on the side of transmitter and magnet are closed to each other and within the range of 1cm. As long as the space between transmitter and magnet is over 2cm; The status indicator on the transmitter will blink once.

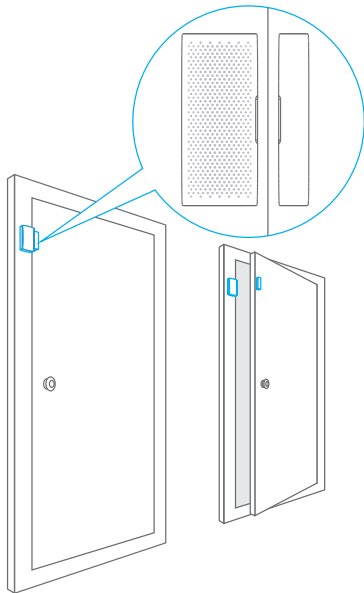

Mounting the PIR Motion Detector

Important: Avoid installing the motion detector directly towards windows and near heat sources, such as heat extraction units, air-condition, micro-wave oven, refrigerator etc; Avoid placing two motion detectors in the opposite of each other; Don't place them in each other's detection range.

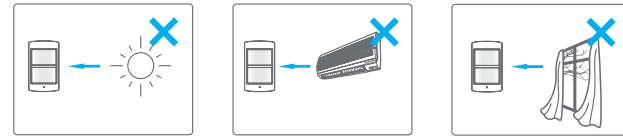

Step 1: The ideal mounting height of the motion detector is 2-2.2 meters from the floor. It is suggested to mount it at the corner of the wall by using the supplied 3M sticker.

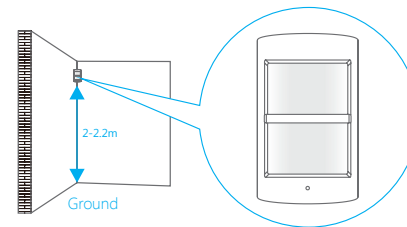

Step 2: Press the test button twice and walk from left to right in the room. The status indicator will blink once when motion is detected.

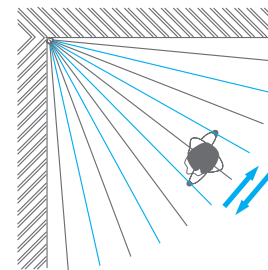

Note: This PIR motion detector can also be mounted at special location by using the supplied bracket and screw kits.

Pairing/Deleting Accessory

The included accessories have been paired with the control panel by default, if you want to pair new accessories, please follow these instructions:

Pairing New Remote Control and Sensor

Enter the disarm password (default: 1234); then press the [🔓] button on the control panel and trigger the sensors once.

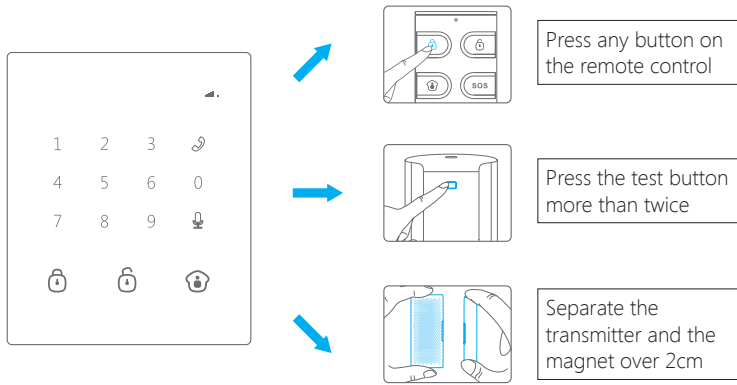

When a beep is heard from the control panel, the sensor is paired successfully. If two beeps are heard, the sensor has already been paired before.

Note: To pair other sensors, please refer to the related user manuals.

Pairing New Wireless Siren

Siren is sold separately.

1. Make sure the siren enters pairing state (please refer to relevant user manual).
2. Press [🔓] or [🔒] on the control panel to send out a pairing signal to the siren.
When a beep is heard from the siren, the siren is paired successfully. If two beeps are heard, the siren has already been paired before.

If a wireless siren is paired, you can turn on or off the arm/disarm tone by sending "63701" or "63700" to the control panel (The default setting is off).

Deleting Sensors

Send SMS with content "21" to the control panel, then you will receive an SMS to confirm the successful deletion of sensors.

Send SMS with content "23" to the control panel, then you will receive an SMS to confirm the successful deletion of remote controls.

Deleting Wireless Siren

Press and hold the pair button of the wireless siren; the deletion is succeeded when two beeps are heard from the wireless siren.

Reload the Batteries of Accessories

Remote Control

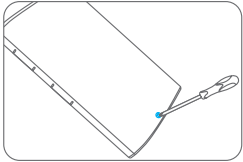

Loose the screw

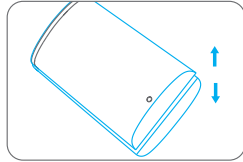

Open the case and change the battery

Door/Windor Contact

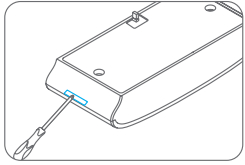

Open the case and change the battery

PIR Motion Detector

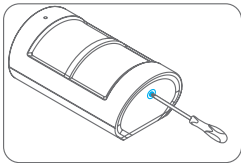

Loose the screw

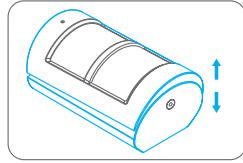

Open the case and change the battery

Arm & Disarm by Free Phone Call

Arming the alarm system can be done by calling the SIM card No. in the control panel. Hanging up the call after you hear the dialing tone, and then you will be called by the control panel; do not answer the phone call and the system will be armed.

Disarming the alarm system can be done by calling the SIM card No. in the control panel. Do not hang up until the system disconnected by itself. The alarm system will not call you back and the system is disarmed.

Restore to Factory Settings

Send text "0000" to the control panel; the system will be restored to factory settings, but the paired sensors remain working.

Specifications

Control Panel

Power Supply	DC12V 500 mA
Battery	3.7V 600 mAh Li-ion Battery
GSM Frequency	850/900/1800/1900 MHz
Standby Current	<56 mA
Alarm Current	<270 mA
Internal Siren	90 dB
Expandable Accessories	10 Remote Controls, 50 Sensors
Radio Frequency	315 MHz or 433.92 MHz
Housing Material	ABS Plastic
Operating Condition	Temperature -10°C~+55°C Relative Humidity <80% (non-condensing)
Control Panel Dimensions	87.5 x 81.5 x 12 mm (L x W x H)
Bracket Dimensions	71 x 34 x 17.5 mm (L x W x H)

Remote Control

Power Supply	DC 3V (CR2025 lithium battery x 1pc)
Transmit Current	<7 mA
Transmitting Distance	<80 m (open area/no interference)
Radio Frequency	315 MHz or 433.92 MHz
Housing Material	ABS Plastic
Operating Condition	Temperature -10°C~+55°C Relative Humidity <80% (non-condensing)
Dimensions	53 x 31 x 11 mm (L x W x H)

Door/Window Contact

Power Supply	DC 6V (CR2032 lithium battery x 2pcs)
Static Current	<35 uA
Alarm Current	<40 mA
Transmitting Distance	<80 m (open area/no interference)
Radio Frequency	315 MHz or 433.92 MHz
Housing Material	ABS Plastic
Operating Condition	Temperature -10°C~+55°C Relative Humidity <80% (non-condensing)
Transmitter Dimensions	71 x 31.5 x 15 mm (L x W x H)
Magnet Dimensions	71 x 12.5 x 15 mm (L x W x H)

PIR Motion Detector

Power Supply	DC 3V (AA 1.5V LR6 battery x 2 pcs)
Static Current	<50 uA
Alarm Current	<9.5 mA
Detection Scope	8m/110°
Transmitting Distance	<80 m (open area/no interference)
Radio Frequency	315 MHz or 433.92 MHz
Housing Material	ABS Plastic
Operation Condition	Temperature -10°C~+55°C Relative Humidity <80% (non-condensing)
Detector Dimensions	100 x 59 x 43 mm (L x W x H)
Bracket Dimensions	52 x 30 x 26.5 mm (L x W x H)

Disclaimer

Dear users,

We have reviewed this manual thoroughly in order that it will be an easy to use guide to this product. All statements, technical information, recommendations in this manual are believed reliable, but the accuracy and completeness thereof are not guaranteed or warranted.

The specifications and information regarding the products in this document are subject to change without notice.

Photocopy, copy, reproduction, translation to any language, modification, storage in a retrieval system or retransmission, in any form or by any means, electronic, mechanical or otherwise, is strictly prohibited without prior written permission.

In no event we are liable for any indirect, special, incidental, or consequential damages, including, without limitation, lost profits or loss or damage to data arising out of the use or inability to use this document, even if the product has been advised of the possibility of such damages.

